

F50360



Z-Power series is designed for high current operation and high flux output applications.

Z-Power LED's thermal management perform exceeds other power LED solutions.

It incorporates state of the art SMD design and Thermal emission material.

Full color Z-Power LED is using 3 RGB power chips and rendering 7colors.

In case of the full color product used in architectural lighting or decoration, it emits 7colors in one package so that it can render a clear mixed color when it is mixed with other colors.

F50360

Features

- Super high Flux output and high Luminance
- Designed for high current operation
- Low thermal resistance
- SMT solder ability
- Lead Free product
- RoHS compliant

Applications

- Mobile phone flash
- Automotive interior / exterior lighting
- Automotive signal lighting
- Automotive forward lighting
- Architectural lighting
- LCD TV / Monitor Backlight
- Projector light source
- Traffic signals
- Task lighting
- Decorative / Pathway lighting
- Remote / Solar powered lighting
- Household appliances

Full Code of Z-Power LED Series

Full code form : $X_1 X_2 X_3 X_4 X_5 X_6 - X_7 X_8 - X_9 X_{10} X_{11} X_{12} X_{13}$

1. Part Number

- X_1 : Color
- X_2 : Z-Power LED series number
- X_3 : LENS type
- X_4 : Chip quantity (or Power Dissipation)
- X_5 : Package outline size
- X_6 : Type of PCB





2. Internal Number

- X_7
- X_8

3. Code Labeling

- X_9 : Luminous flux (or Radiant flux for royal blue)
- $X_{10} X_{11} X_{12}$: Dominant wavelength (or x,y coordinates rank code)
- X_{13} : Forward voltage

4. Sticker Diagram on Reel & Aluminum Vinyl Bag

PART NO. : $X_1 X_2 X_3 X_4 X_5 X_6 - X_7 X_8$

 QUANTITY : ###

 LOT NUMBER : #####

 BIN CODE : $X_9 X_{10} X_{11} X_{12} X_{13}$

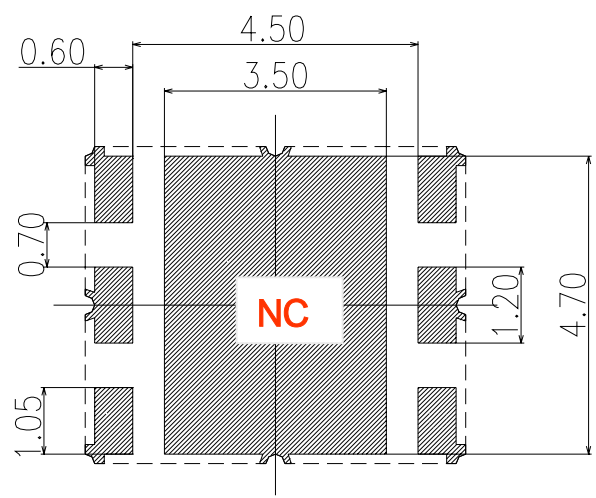
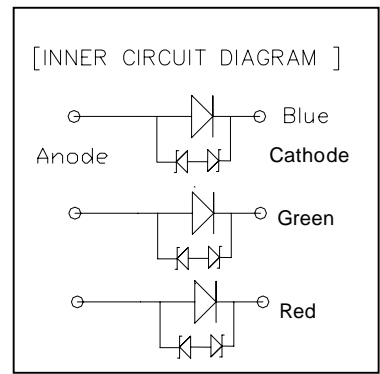
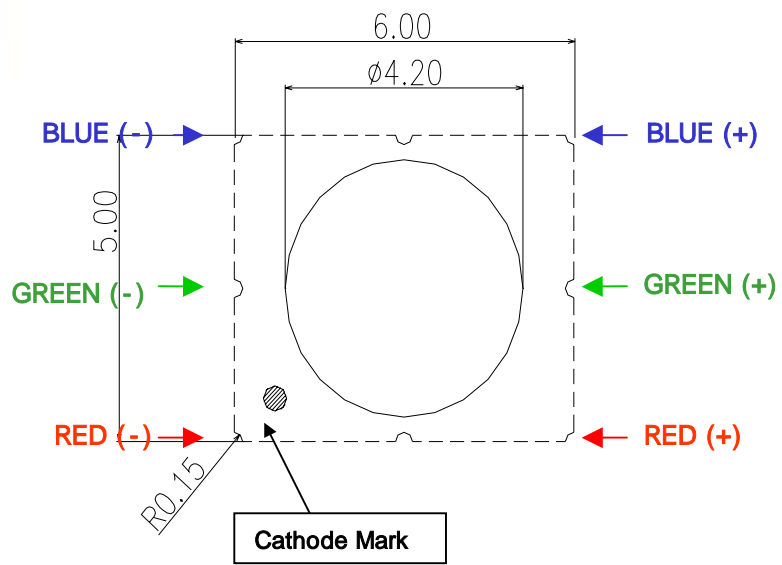

For more information about binning and labeling, refer to the Application Note -1

Outline Dimensions

1. Emitter Type



<Rear view>

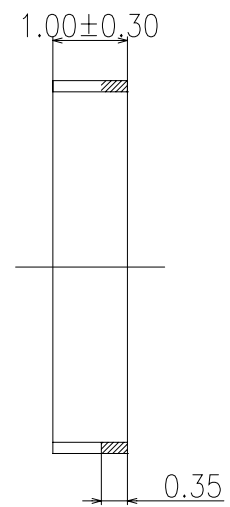

Notes :

1. Tolerance is ± 0.2 mm (If not noted)
2. Scale : none
3. NC PAD isn't connected to anode or cathode

*The appearance and specifications of the product may be changed for improvement without notice.

Characteristics for Z-Power LED

1. Electro-Optical characteristics at (Red, Green, and Blue All Color in use)

1-1 Electro-Optical characteristics at $T_A=25^{\circ}\text{C}$

Parameter	Symbol	Value			Unit
		Min	Typ	Max	
Luminous Flux ^[1]	Φ_V ^[2]	-	105 (78) ^[3]	-	lm
Forward Voltage ^[4]	V_F	-	R: 2.5 G: 3.5 B: 3.3	R: 3 G: 4 B: 4	V
Forward Current	I_F	R,G,B: 350			mA
View Angle ^[5]	2 1/2	120			deg.
Thermal Resistance ^[6]	$R_{\theta J-C}$	R: 25, G: 25, B: 22 @ White Balance ^[3]			$^{\circ}\text{C} / \text{W}$

1-2 Absolute Maximum Ratings

Parameter	Symbol	Value			Unit
		Red	Green	Blue	
Forward Current	I_F	400	400	400	mA
		700 (@1KHz, 1/10duty)			
Power Dissipation	P_d	1.2	1.6	1.6	W
Junction Temperature	T_j	125	145	145	$^{\circ}\text{C}$
Operating Temperature	T_{opr}	-30 ~ +85			$^{\circ}\text{C}$
Storage Temperature	T_{stg}	-40 ~ +100			$^{\circ}\text{C}$
ESD Sensitivity ^[7]	-	$\pm 10,000\text{V}$ HBM			-

*Notes :

- [1] SSC maintains a tolerance of $\pm 10\%$ on flux and power measurements.
- [2] Φ_V is the total luminous flux output as measured with an integrated sphere under 350 mA red, green and blue.
- [3] Reference white balance current condition ($I_F=R:220, G:350, B:100$ mA)
- [4] A tolerance of $\pm 0.1\text{V}$ on forward voltage measurements
- [5] Viewing angle is the reference condition.
- [6] $R_{\theta J-C}$ is measured whit only emitter .($25^{\circ}\text{C} \leq T_j \leq 110^{\circ}\text{C}$)
- [7] It is included the zener chip to protect the product from ESD.

-----Caution-----

1. Please do not drive at rated current more than 5 sec. without proper heat sink

Characteristics for Z-Power LED

2. Blue

2-1 Electro-Optical characteristics at $I_F=350\text{mA}$, $T_A=25^\circ\text{C}$

Parameter	Symbol	Value			Unit
		Min	Typ	Max	
Luminous Flux [1]	Φ_V [2]	-	13	-	lm
Dominant Wavelength [3]	λ_D	455	460	465	nm
Forward Voltage [4]	V_F	-	3.2	4	V
View Angle [5]	2 1/2	120			deg.
Thermal Resistance [6]	$R\theta_{J-C}$	14			$^\circ\text{C} / \text{W}$

2-2 Absolute Maximum Ratings

Parameter	Symbol	Value	Unit
Forward Current	I_F	400	mA
		700 (@1KHz, 1/10duty)	
Power Dissipation	P_d	1.6	W
Junction Temperature	T_j	145	$^\circ\text{C}$
Operating Temperature	T_{opr}	-30 ~ +85	$^\circ\text{C}$
Storage Temperature	T_{stg}	-40 ~ +100	$^\circ\text{C}$
ESD Sensitivity [7]	-	$\pm 10,000\text{V HBM}$	-

*Notes :

- [1] SSC maintains a tolerance of $\pm 10\%$ on flux and power measurements.
- [2] Φ_V is the total luminous flux output as measured with an integrated sphere.
- [3] Dominant wavelength is derived from the CIE 1931 Chromaticity diagram.
A tolerance of $\pm 1.0\text{nm}$ for dominant wavelength
- [4] A tolerance of $\pm 0.1\text{V}$ on forward voltage measurements
- [5] Viewing angle is the reference condition.
- [6] R_{J-C} is measured whit only emitter . ($25^\circ\text{C} \leq T_J \leq 110^\circ\text{C}$)
- [7] It is included the zener chip to protect the product from ESD.

-----Caution-----

1. Please do not drive at rated current more than 5 sec. without proper heat sink

Characteristics for Z-Power LED

3. Green

3-1 Electro-Optical characteristics at $I_F=350\text{mA}$, $T_A=25^\circ\text{C}$

Parameter	Symbol	Value			Unit
		Min	Typ	Max	
Luminous Flux ^[1]	Φ_V ^[2]	-	57	-	lm
Dominant Wavelength ^[3]	λ_D	520	525	535	nm
Forward Voltage ^[4]	V_F	-	3.5	4	V
View Angle ^[5]	2 1/2	120			deg.
Thermal Resistance ^[6]	$R_{\theta_{J-C}}$	16			$^\circ\text{C} / \text{W}$

3-2 Absolute Maximum Ratings

Parameter	Symbol	Value	Unit
Forward Current	I_F	400	mA
		700 (@1KHz, 1/10duty)	
Power Dissipation	P_d	1.6	W
Junction Temperature	T_j	145	$^\circ\text{C}$
Operating Temperature	T_{opr}	-30 ~ +85	$^\circ\text{C}$
Storage Temperature	T_{stg}	-40 ~ +100	$^\circ\text{C}$
ESD Sensitivity ^[7]	-	$\pm 10,000\text{V}$ HBM	-

*Notes :

- [1] SSC maintains a tolerance of $\pm 10\%$ on flux and power measurements.
- [2] Φ_V is the total luminous flux output as measured with an integrated sphere.
- [3] Dominant wavelength is derived from the CIE 1931 Chromaticity diagram.
A tolerance of $\pm 1.0\text{nm}$ for dominant wavelength
- [4] A tolerance of $\pm 0.1\text{V}$ on forward voltage measurements
- [5] Viewing angle is the reference condition.
- [6] R_{J-C} is measured with only emitter. ($25^\circ\text{C} \leq T_J \leq 110^\circ\text{C}$)
- [7] It is included the zener chip to protect the product from ESD.

-----Caution-----

1. Please do not drive at rated current more than 5 sec. without proper heat sink

Characteristics for Z-Power LED

4. Red

4-1 Electro-Optical characteristics at $I_F=350\text{mA}$, $T_A=25^\circ\text{C}$

Parameter	Symbol	Value			Unit
		Min	Typ	Max	
Luminous Flux ^[1]	Φ_V ^[2]	-	35	-	lm
Dominant Wavelength ^[3]	λ_D	618	625	630	nm
Forward Voltage ^[4]	V_F	-	2.5	3	V
View Angle ^[5]	2 1/2	120			deg.
Thermal Resistance ^[6]	$R\theta_{J-C}$	16			$^\circ\text{C} / \text{W}$

4-2 Absolute Maximum Ratings

Parameter	Symbol	Value	Unit
Forward Current	I_F	400	mA
		700 (@1KHz, 1/10duty)	
Power Dissipation	P_d	1.2	W
Junction Temperature	T_j	125	$^\circ\text{C}$
Operating Temperature	T_{opr}	-30 ~ +85	$^\circ\text{C}$
Storage Temperature	T_{stg}	-40 ~ +100	$^\circ\text{C}$
ESD Sensitivity ^[6]	-	$\pm 10,000\text{V}$ HBM	-

*Notes :

- [1] SSC maintains a tolerance of $\pm 10\%$ on flux and power measurements.
- [2] Φ_V is the total luminous flux output as measured with an integrated sphere.
- [3] Dominant wavelength is derived from the CIE 1931 Chromaticity diagram.
A tolerance of $\pm 1.0\text{nm}$ for dominant wavelength
- [4] A tolerance of $\pm 0.1\text{V}$ on forward voltage measurements
- [5] Viewing angle is the reference condition.
- [6] R_{J-C} is measured with only emitter. ($25^\circ\text{C} \leq T_J \leq 110^\circ\text{C}$)
- [7] It is included the zener chip to protect the product from ESD.

-----Caution-----

1. Please do not drive at rated current more than 5 sec. without proper heat sink

Color spectrum, $T_A=25^{\circ}\text{C}$

1. Pure White (IF = R:220, G:350, B:100 mA for the reference condition)

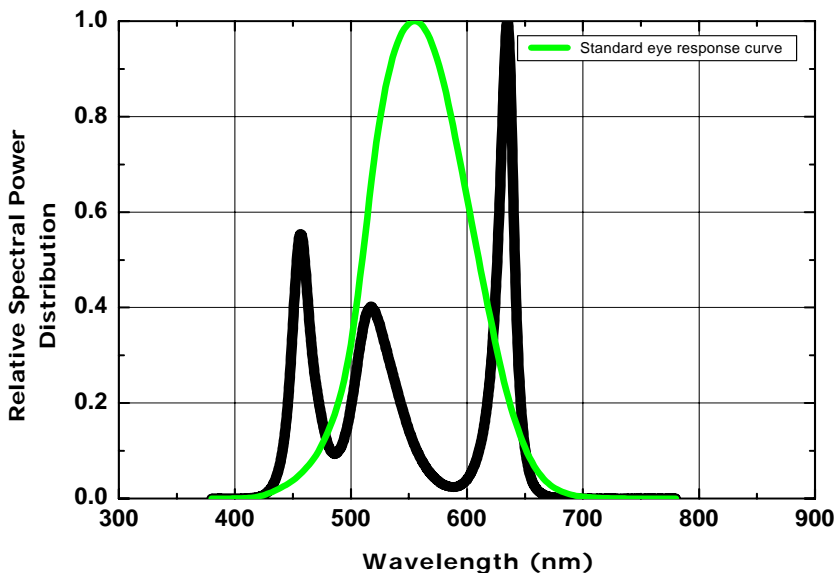

2. Blue, Green, Red (IF= 350mA)

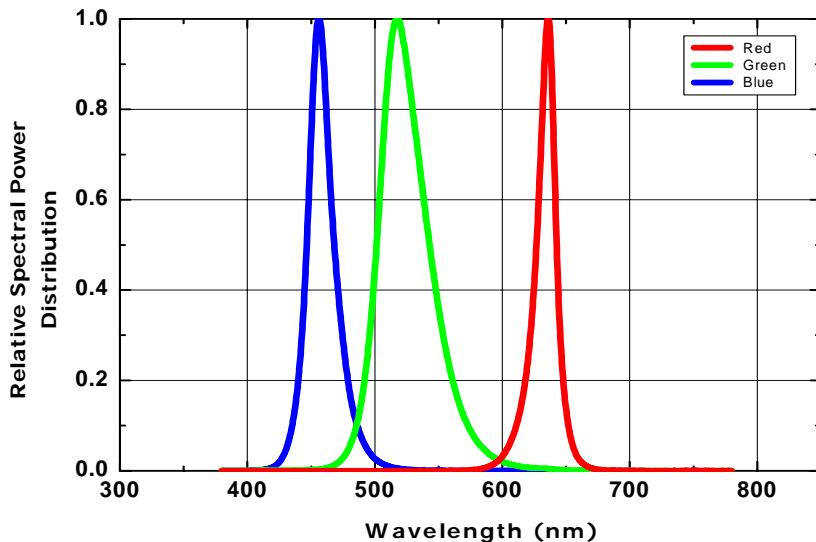

Junction Temperature Characteristics

1. Junction Temperature vs. Relative Light output at 350mA

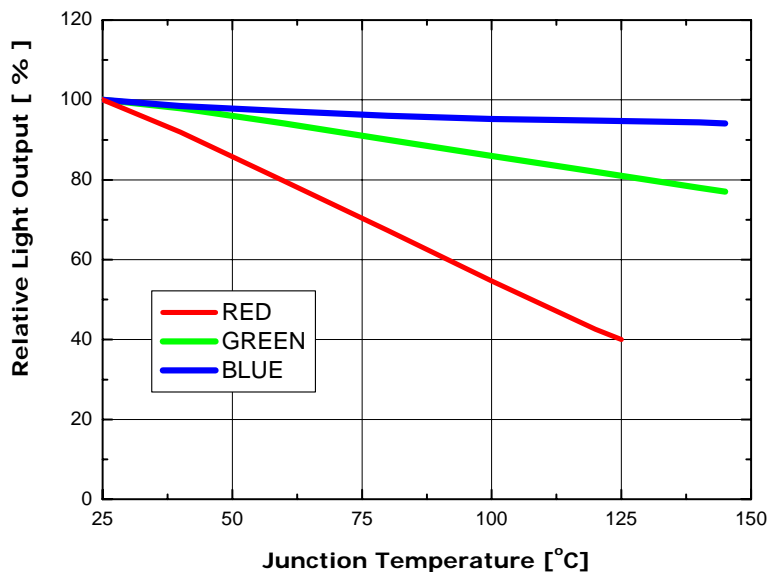

2. Junction Temperature vs. Dominant Wavelength Shift at 350mA

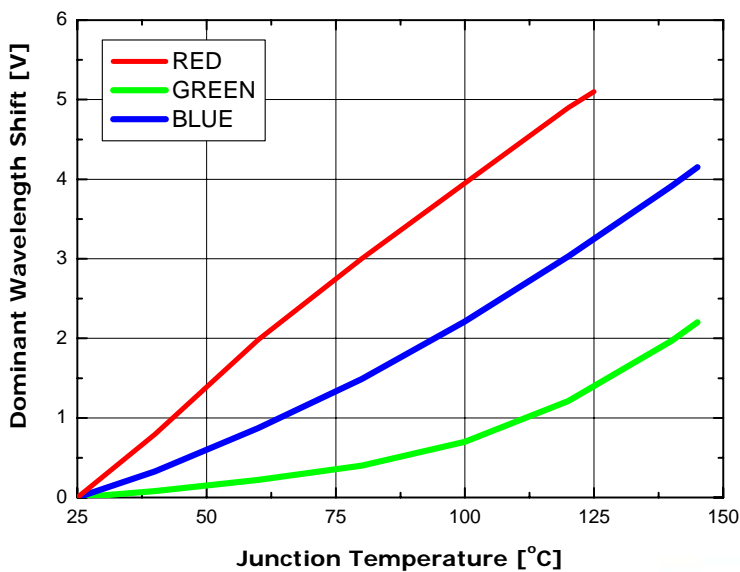

Junction Temperature Characteristics

3. Junction Temperature vs. Forward Voltage Shift at 350mA

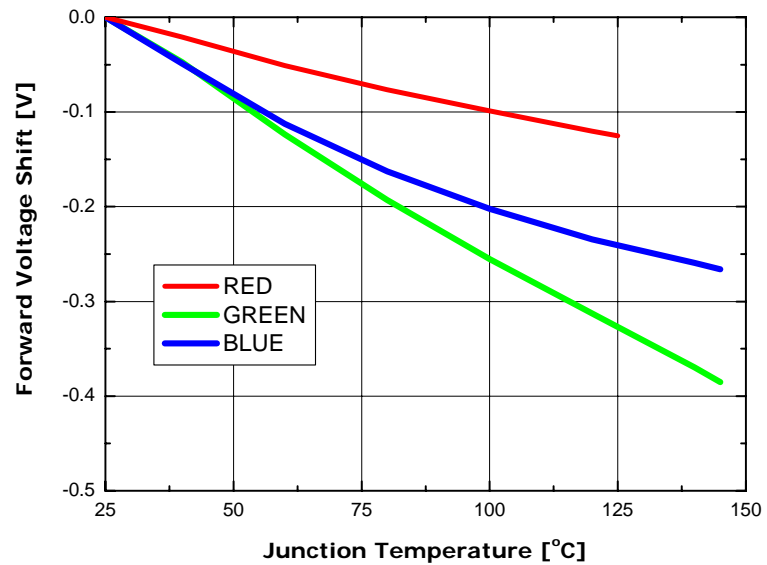

Forward Current Characteristics

1. Forward Voltage vs. Forward Current, $T_A=25$

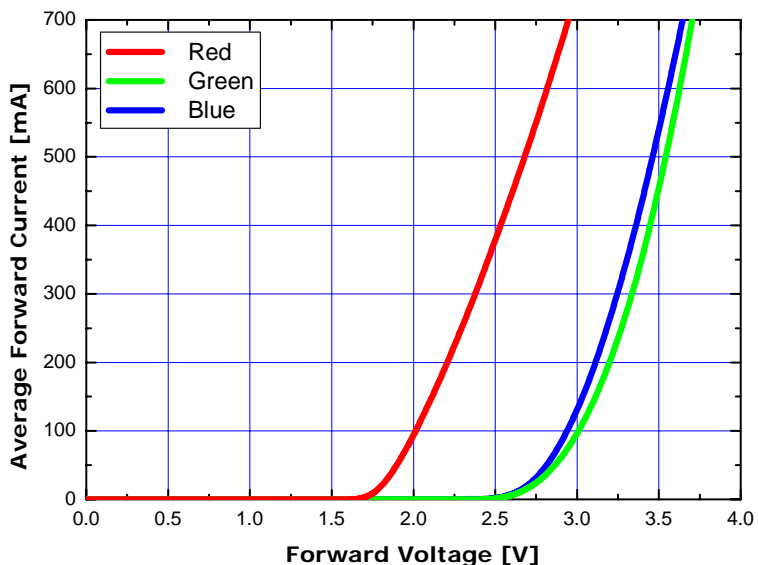

2. Forward Current vs. Normalized Relative Luminous Flux, $T_A=25$

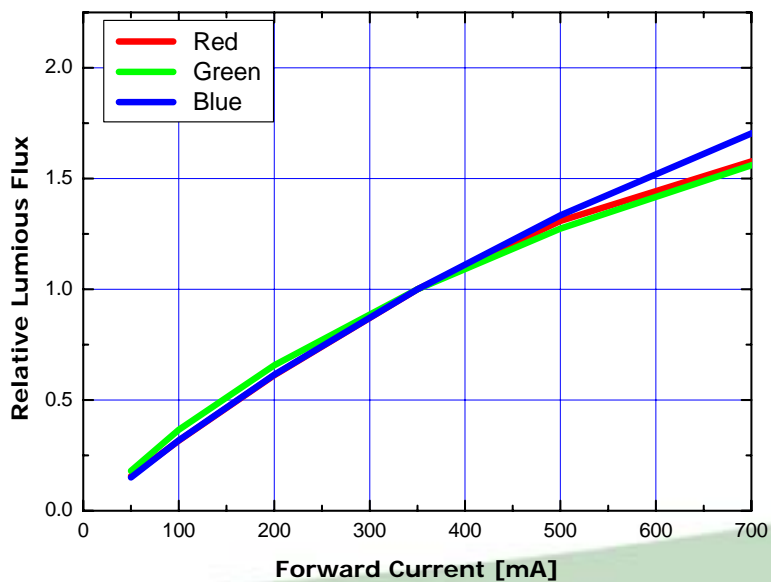

Forward Current Characteristics

3. Forward Current vs Wavelength shift $T_A=25$

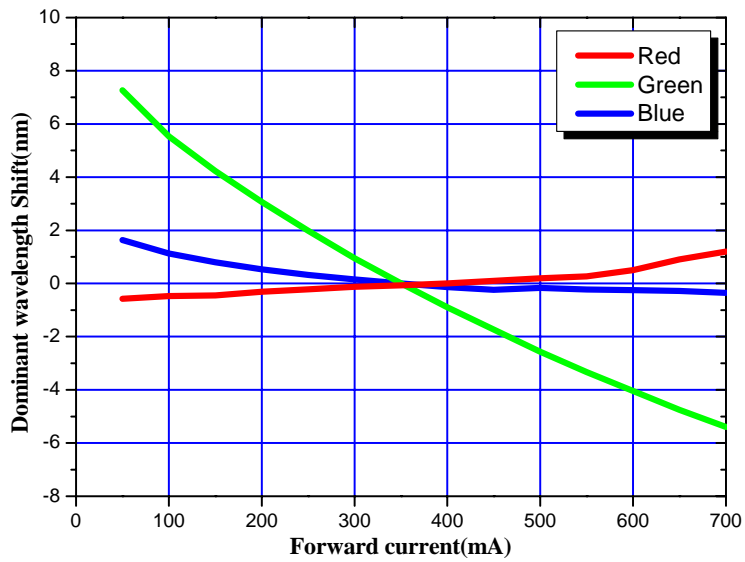

Ambient Temperature vs Allowable Forward Current

1. Blue, Green ($T_{JMAX} = 145\text{ }^{\circ}\text{C}$)

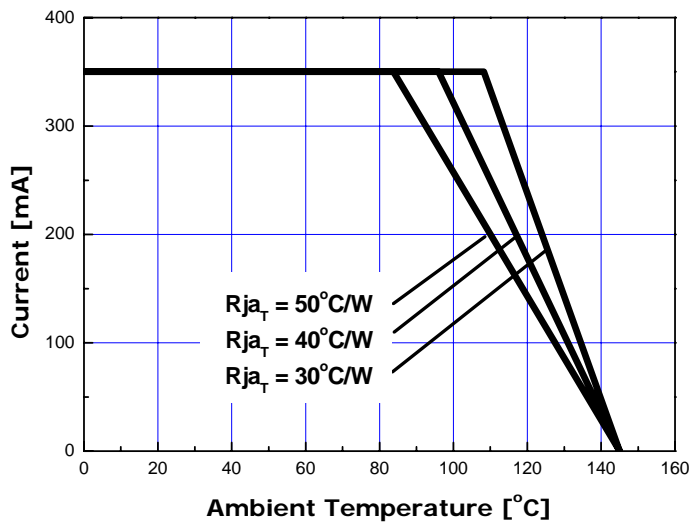

2. Red ($T_{JMAX} = 125\text{ }^{\circ}\text{C}$)

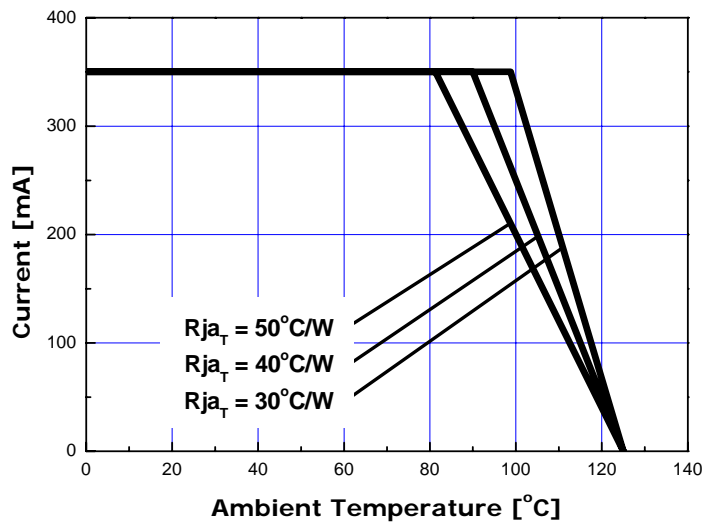

Typical Dome Type Radiation pattern

1. Pure White

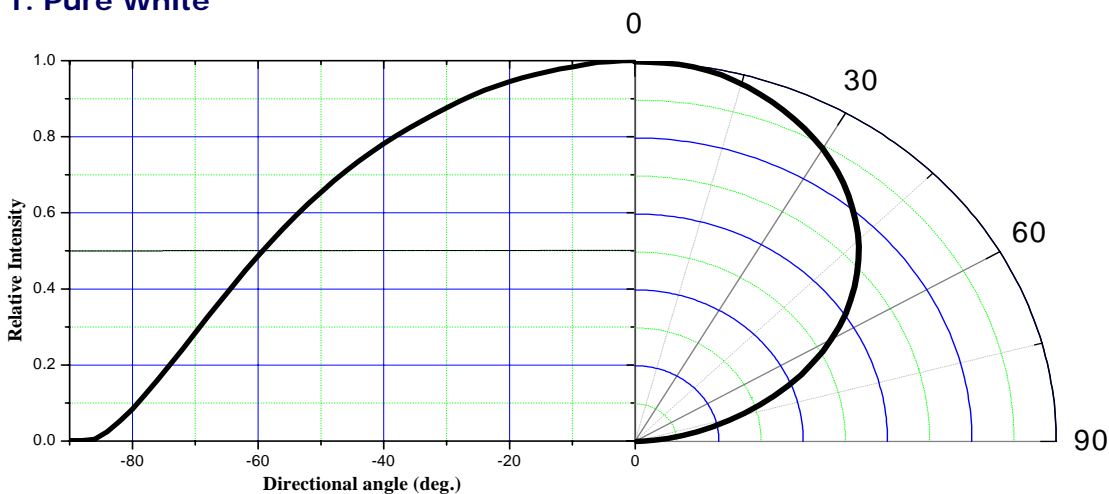

2. Red, Green, Blue

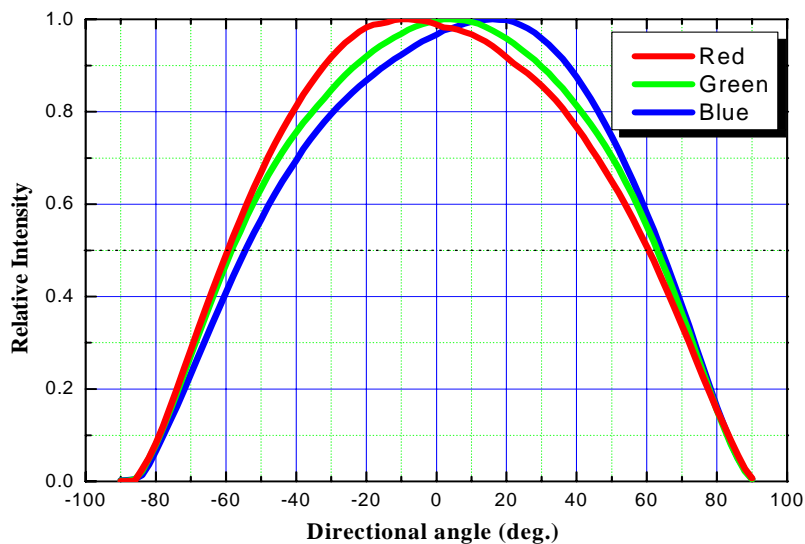

Soldering profile, $T_A=25^{\circ}\text{C}$

1. Reflow Soldering Conditions / Profile

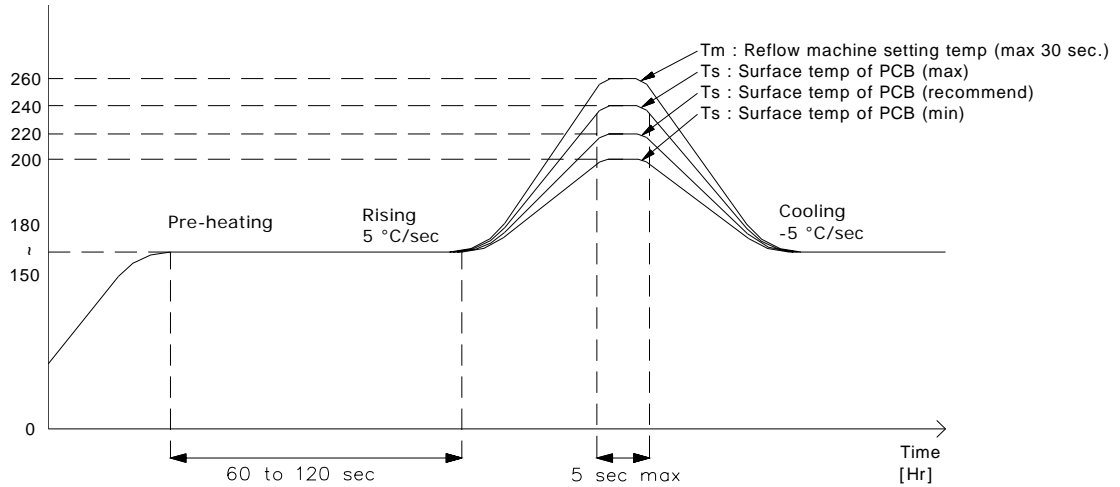

2. Hand Soldering conditions

Pad : Not more than 3 seconds @MAX280

* Caution

1. Reflow soldering should not be done more than one time.
2. Repairing should not be done after the LEDs have been soldered.
When repairing is unavoidable, suitable tools have to be used.
3. Pad is to be soldered.
4. When soldering, do not put stress on the LEDs during heating.
5. After soldering, do not warp the circuit board.
6. Recommend to use a convection type reflow machine with 7 ~ 8 zones.

Recommended Soldering

1. Solder pad

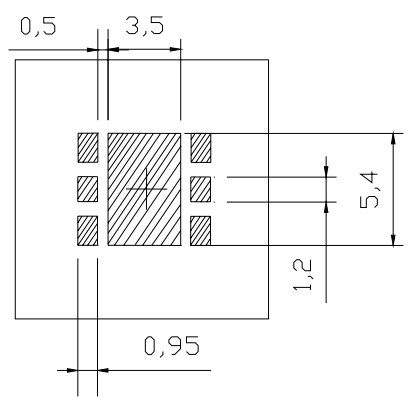
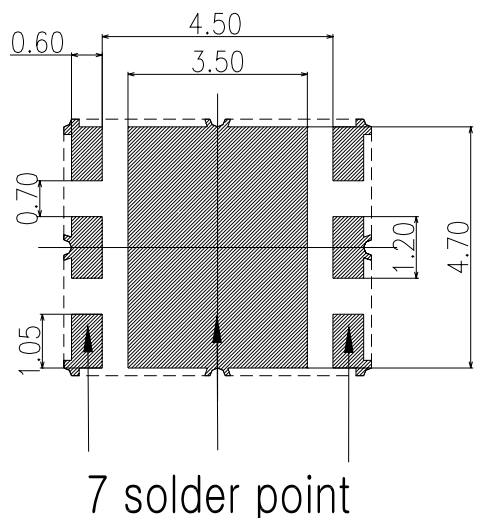
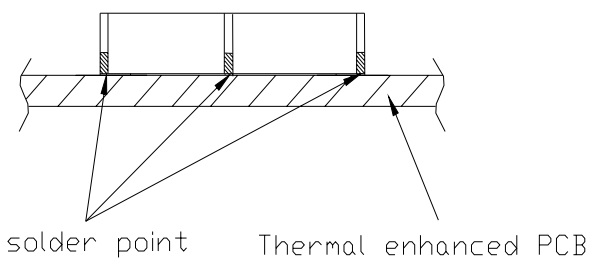

Note :

1. All dimensions are in millimeters (tolerance : ± 0.2)
 2. Scale none
- *The appearance and specifications of the product may be changed for improvement without notice.

Reel Packaging

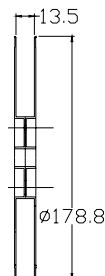
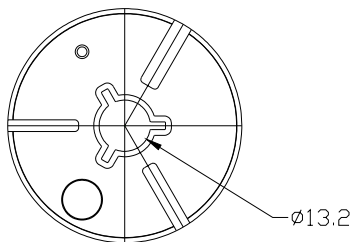
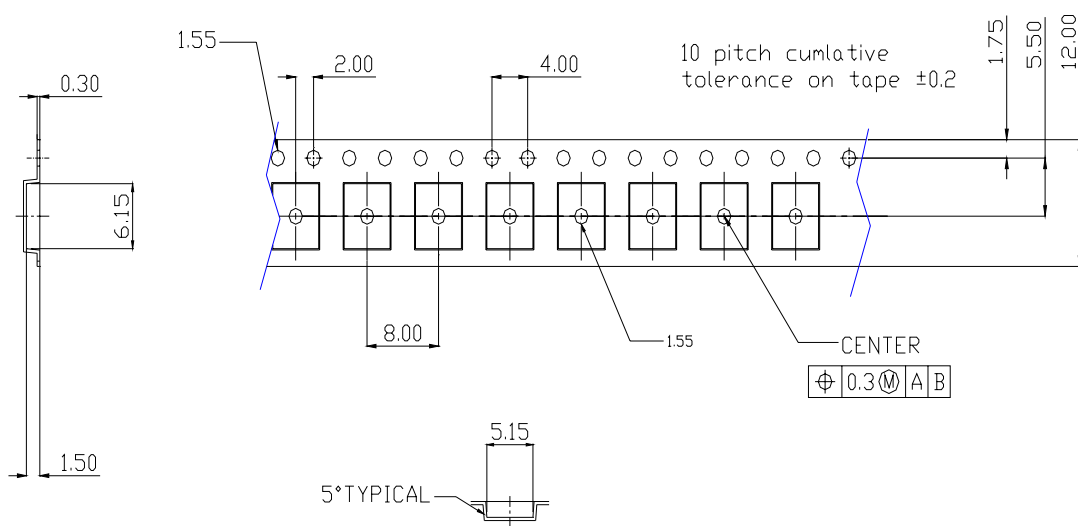

Note :

1. The number of loaded products in the reel is 1000ea
2. All dimensions are in millimeters. (tolerance : ± 0.2)
3. Scale : none

*The appearance and specifications of the product may be changed for improvement without notice.

Precaution for use

- Storage

To avoid the moisture penetration, we recommend storing Z Power LEDs in a dry box (or desiccator) with a desiccant . The recommended storage conditions are Temperature 5 to 30 degrees Centigrade. Humidity 50% maximum.

- Precaution after opening packaging

However LED is correspond SMD, when LED be soldered dip, interfacial separation may affect the light transmission efficiency, causing the light intensity to drop.

Attention in followed.

- a. Soldering should be done right after opening the package(within 24Hrs).
 - b. Keeping of a fraction
 - Sealing
 - Temperature : 5 ~ 40 Humidity : less than 30%
 - c. If the package has been opened more than 1week or the color of desiccant changes, components should be dried for 10-12hr at 60±5
- Any mechanical force or any excess vibration shall not be accepted to apply during cooling process to normal temp. after soldering.
 - Please avoid rapid cooling after soldering.
 - Components should not be mounted on warped direction of PCB.
 - Anti radioactive ray design is not considered for the products listed here in.
 - Gallium arsenide is used in some of the products listed in this publication. These products are dangerous if they are burned or shredded in the process of disposal. It is also dangerous to drink the liquid or inhale the gas generated by such products when chemically disposed.
 - This device should not be used in any type of fluid such as water, oil, organic solvent and etc. When washing is required, IPA(Isopropyl Alcohol) should be used.
 - When the LEDs are illuminating, operating current should be decided after considering the package maximum temperature.
 - LEDs must be stored to maintain a clean atmosphere. If the LEDs are stored for 3 months or more after being shipped from SSC, a sealed container with a nitrogen atmosphere should be used for storage.
 - The appearance and specifications of the product may be modified for improvement without notice.
 - Long time exposure of sunlight or occasional UV exposure will cause lens discoloration.
 - Attaching LEDs, don't use adhesives to generate organic vapor.

Handling of Silicone resin LEDs

Z-Power LED is encapsulated by silicone resin for the highest flux efficiency.

Notes for handling of Silicone resin Z-Power LEDs

- Avoid touching silicone resin parts especially by sharp tools such as Tweezers
- Avoid leaving fingerprints on silicone resin parts.
- Please store the LEDs away from dusty areas or seal the product against dust.
- When populating boards in SMT production, there are basically no restrictions regarding the form of the pick and place nozzle, except that mechanical pressure on the surface of the resin must be prevented.
- Please do not mold over the silicone lens with another resin.
(epoxy, urethane, etc)