

TCA connectors:
AdvancedTCA[®] and MicroTCA[™]

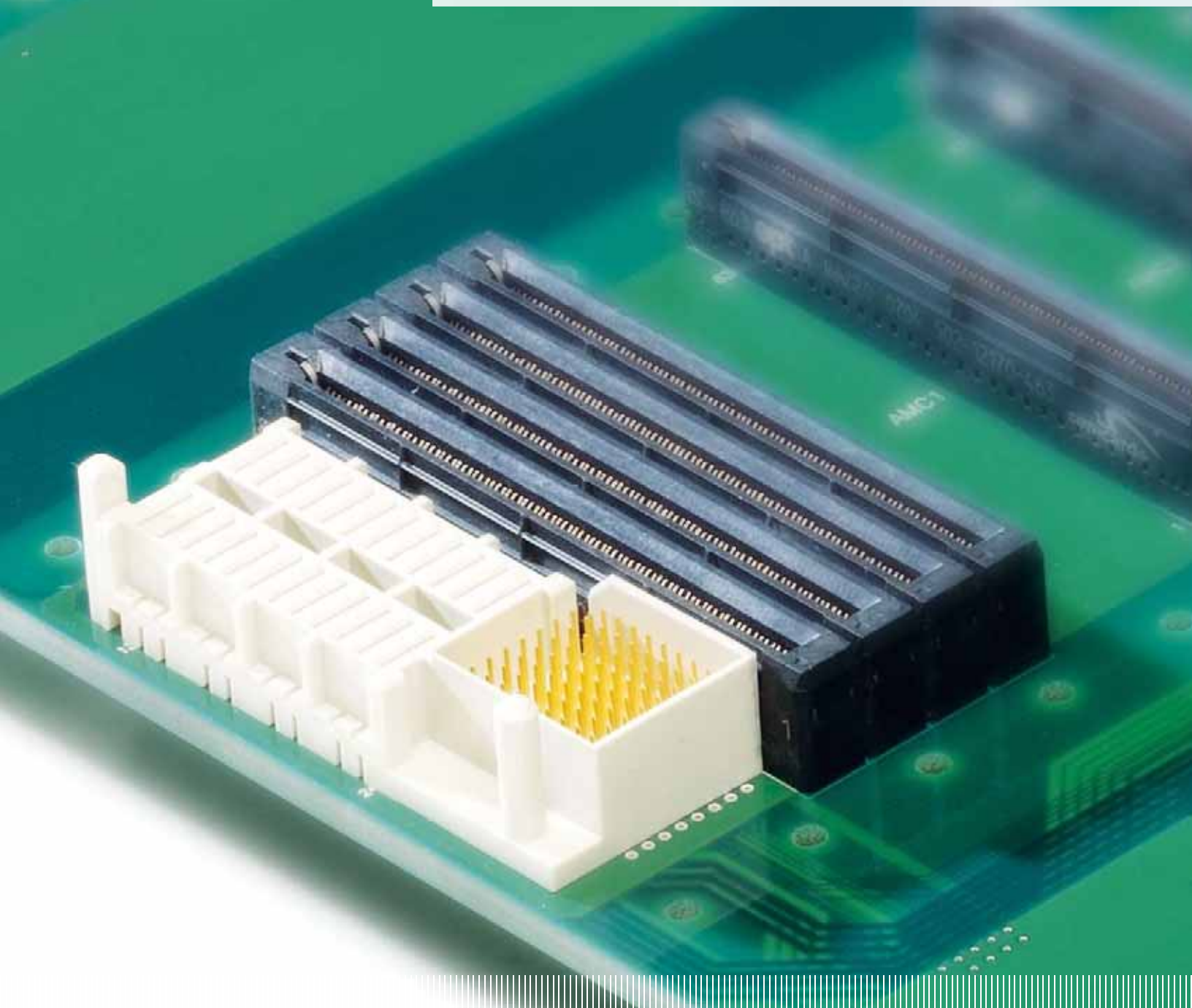

Definitions	12
Technical specifications	14
Derating diagrams	16
Hole specifications	17
AdvancedTCA® Signal AMC B+	19
AdvancedTCA® Power	20
Notes	22
MicroTCA™ Signal AMC	23
MicroTCA™ Power	24

AdvancedTCA®/MicroTCA™

AdvancedTCA®

To give consideration to increasing data traffic and new communication services, the PICMG® has developed and adopted the AdvancedTCA® specification (ATCA). AdvancedTCA® is mainly aimed at the infrastructure of telecommunications systems requiring maximum availability. With AdvancedTCA® it is possible to set up modular systems with modules from different manufacturers. This technology thus offers the possibility to develop flexible and low-cost systems faster than previously possible with proprietary systems.

AdvancedTCA® is a scalable, powerful architecture with a high degree of functionality, availability and future safety. Many future-oriented applications can be implemented on this platform. Further advantages are scalable data rates of several Tbit/s, support of multi-protocols, new services can be integrated, the convergence of access, core and optical networks as well as the integration of computer center functions. Interfaces for Gigabit Ethernet, Fibre Channel, Infiniband, StarFabric, PCI-Express and RapidIO are evidence of the high flexibility of the AdvancedTCA® architecture. Another core feature of the systems is their high availability of 99.999 %.

AdvancedTCA® is mainly used for telecommunications applications and can be optimally used, for example, for:

- Wireless
- Wireline
- Voice over IP
- Video on Demand
- Media gateways
- Broadband platform services

μTCA™

In order to make the described AdvancedTCA® system even more cost-effective, the PICMG® has developed the AdvancedMC™ standard (Advanced Mezzanine Card). The AdvancedMC™ modules are small cards that are plugged in parallel onto a "Carrier Board" (a carrier board in the form of an AdvancedTCA® subcard) as Mezzanine application. The Carrier Board contains only management functions, the actual application is implemented by means of the AdvancedMC™ modules. MicroTCA™ is based on the approach to plug the AdvancedMC™ modules direct into the backplane. The objective is to create smaller and more flexible systems that do not depend on Carrier Boards and AdvancedTCA®. MicroTCA™ is targeted at applications that do not require a very high computing performance but rather where low space requirements and low costs are important.

This also opens up further application possibilities in the mid and low-end range - not only for telecommunication technology but also:

- Communication
 - Base stations
 - Media gateways
 - Video on demand
- Industrial automation
- Process automation
- Military technology
- Mobile applications
- Medical technology
- Image processing
- Automotive



The "PCI Industrial Computer Manufacturing Group" (PICMG®) is an association of approx. 450 companies. The objective of this group is to develop open standard architectures. The advantages for system developers and end users are low costs due to high quantities, a wide range of available components from many manufacturers and shorter development times for new applications.

In addition to the passive backplanes ISA/PCI and the CompactPCI standard, AdvancedTCA®, AdvancedMC™ and MicroTCA™ are further PICMG® specifications. The specifications are worked out in individual work groups from the participating companies. ept with its experience as connector manufacturer is actively participating in these work groups.



Quality with a seal – **con:card+®**

con:card+® is a quality seal for MicroTCA™ and AdvancedTCA® signal connectors with which the reliability of MicroTCA™ and AdvancedTCA® systems can be increased significantly.

In order to achieve the goal of 99.999 % availability, all system components must be carefully matched to each other and function reliably. Therefore the selection of suitable connectors is especially important, since the tolerances defined in the specification for AdvancedMC™ modules can hardly be observed today. The "GuideSpring" is ideal for compensation. This is only one of five advantages of the **con:card+®** philosophy. All advantages are described in short below and described in more detail in the **con:card+®** features.

- GuideSpring for reliable positioning
- An especially smooth contact surface for protecting the gold-plated PCB pads of the AdvancedMC™ modules
- Wear-resistant plating of the contacts (palladium/nickel with gold flash) improves the wear resistance by approx. 30 %.
- Special contact material with minimum relaxation, even under high contact spring load
- High-quality press-fit connection as efficient connection technology for series processing

con:card+® ensures the maximum availability of your system.

www.concardplus.com

Technical specifications

AdvancedTCA[®] and MicroTCA[™] signal connector

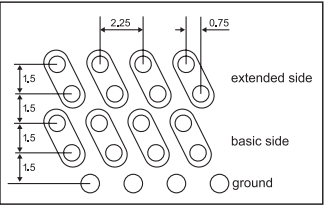
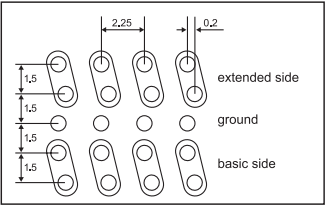
System	AdvancedTCA [®]	MicroTCA [™]
Type	AMC B+ Signal connector CardEdge	AMC Signal connector CardEdge
Specification	PICMG [®] AMC.0	PICMG [®] MTCA.0 R1.0
No. of contacts	170	170
Contact spacing	0.75 mm	0.75 mm
Clearance and creepage distance between the contacts	min. 0.1 mm	min. 0.1 mm
Operational current of 8 power contacts according to specification	1.52 A @ 70 °C max. 30 °C temperature rise	1.52 A @ 70 °C max. 30 °C temperature rise
Operating temperature range	- 55 °C to + 105 °C	- 55 °C to + 105 °C
Test voltage	80 V _{r.m.s}	80 V _{r.m.s}
Contact resistance	max. 60 mΩ (ground contacts) max. 90 mΩ (signal, power, general purpose contacts)	max. 25 mΩ
Insulation resistance	10 ⁸ Ω	10 ⁸ Ω
Mating cycles	200	200
Termination technology	Compliant Pin	Compliant Pin
Engaging force	max. 100 N	max. 100 N
Separating force	max. 65 N	max. 65 N
Impedance (nominal differential)	100 Ω ± 10 %	100 Ω ± 10 %
Cross talk (NEXT-pair to pair) @ 30 ps rise time	<p>Basic to basic < 0.6 % Basic to extended < 0.9 % Extended to extended < 0.6 % Diagonal < 0.3 % Multiline < 3.0 %</p> 	<p>Basic to basic < 0.5 % Basic to extended < 0.2 % Diagonal < 0.1 % Multiline < 2.0 %</p> 
Differential signal propagation time	Basic side: 125 ps Extended side: 145 ps	Basic side: 75 ps Extended side: 75 ps
Differential signal propagation difference	Between basic and extended side: 20 ps Within basic and extended side: ± 2 ps	Between basic and extended side: ± 2 ps Within basic and extended side: ± 2 ps
Insulator material	LCP, UL 94-V0	LCP, UL 94-V0
Contact material	Copper alloy	Copper alloy
Contact surface	Pd/Ni	Pd/Ni
Environment/approvals	RoHS compliant/UL (file: E130314)	RoHS compliant/UL (file: E130314)

Technical specifications AdvancedTCA[®] and MicroTCA[™] Power connector

System	AdvancedTCA [®]	MicroTCA [™]
Type	Power connector Female and male connector	Power connector Backplane and power module output
Specification	PICMG [®] 3.0 R2.0	PICMG [®] MTCA.0 R1.0
No. of contacts	30	96
Power contacts	8	24
Signal contacts	22	72
Operational current	Power contacts: max. 16 A Signal contacts: max. 1 A	Power contacts: max. 12 A Signal contacts: max. 1 A
Operating temperature range	- 55 °C to + 125 °C	- 55 °C to + 105 °C
Test voltage	Contact 1 – 16 1000 V _{r.m.s} Contact 17 – 34 2000 V _{r.m.s}	80 V _{r.m.s}
Contact resistance	Power contacts: ≤ 3 mΩ Signal contacts: ≤ 10 mΩ	Power contacts: ≤ 5 mΩ Signal contacts: ≤ 25 mΩ
Insulation resistance	≥ 10 ¹⁰ Ω	≥ 10 ⁸ Ω
Mating cycles	250	200
Termination technology	Compliant Pin	Compliant Pin
Engaging force	max. 67 N	max. 50 N
Separating force	max. 67 N	max. 50 N
Insulator material	PBT, UL 94-V0	PBT, UL 94-V0
Contact material	Copper alloy	Copper alloy
Contact surface	Au	Power: Au Signal: Pd/Ni
Environment/approvals	RoHS compliant/UL (file: E130314)	RoHS compliant/UL (file: E130314)

Derating diagrams

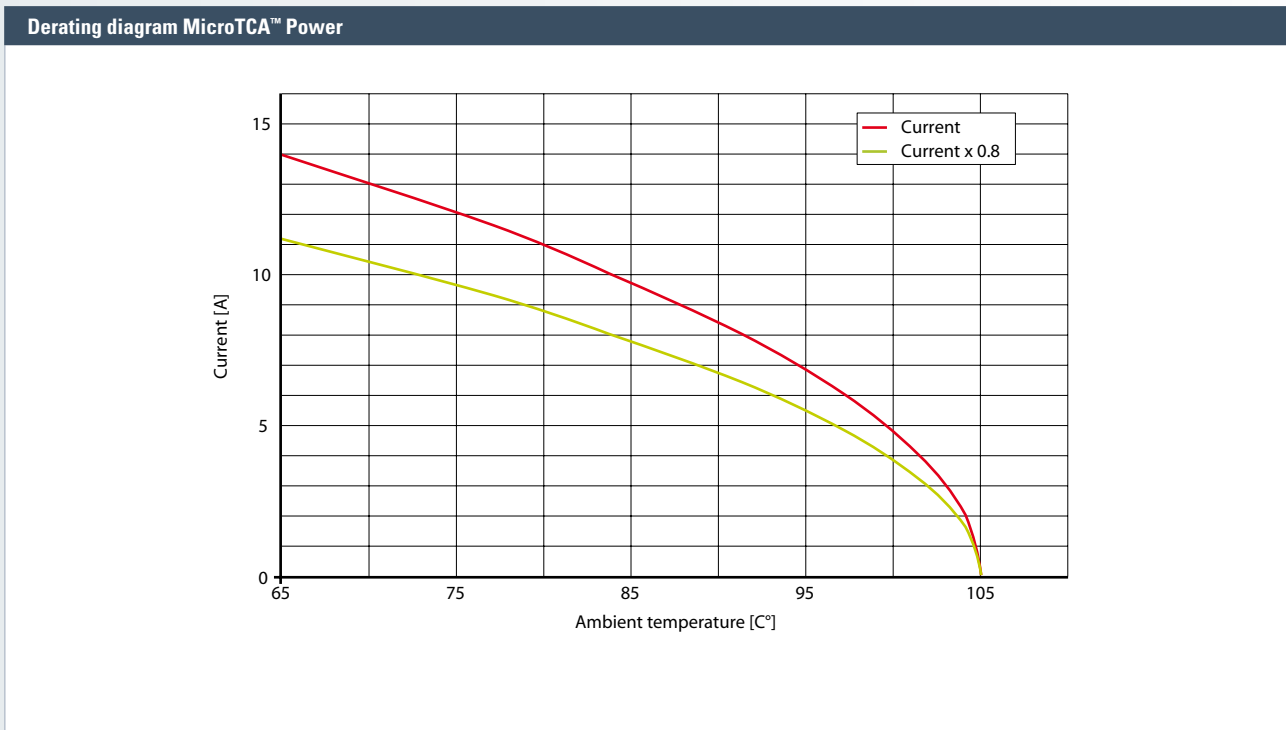
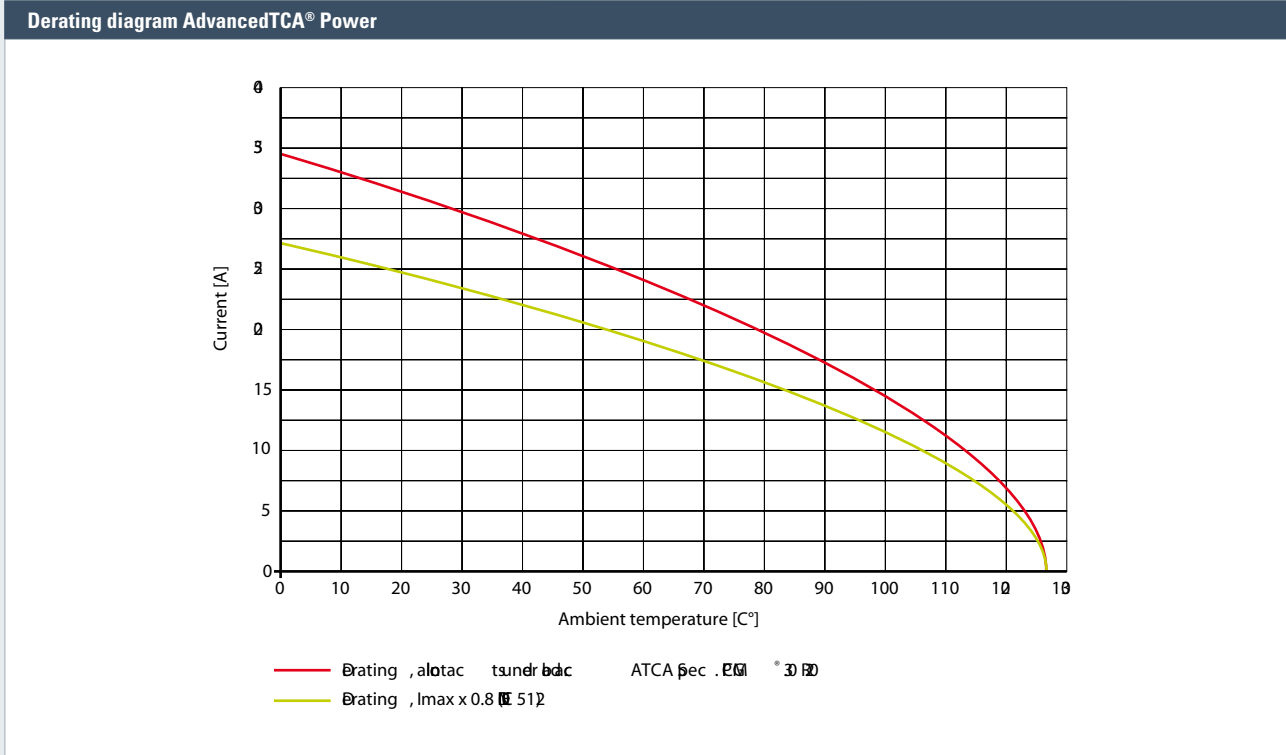

AMC signal connector for AdvancedTCA[®] and MicroTCA[™]

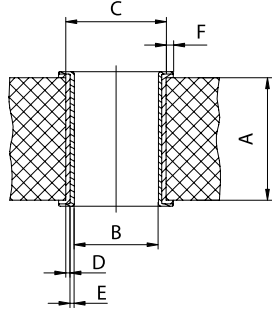

		Nominal hole	Ø 0.55 mm
Imm. Sn printed circuit boards			
A	PCB thickness		min. 1.4 mm
B	Plated hole		Ø 0.55 ± 0.05 mm
C	Drill hole		Ø 0.64 ± 0.01 mm
D	Cu plating		min. 25 µm
E	Imm. Sn plating		max. 1.5 µm
F	Annular ring		min. 0.15 mm
Ni, Au printed circuit boards			
A	PCB thickness		min. 1.4 mm
B	Plated hole		Ø 0.55 ± 0.05 mm
C	Drill hole		Ø 0.64 ± 0.01 mm
D	Cu plating		min. 25 µm
E	Ni, Au plating		0.05 – 0.2 µm Au over 2.5 – 5 µm Ni
F	Annular ring		min. 0.15 mm

AdvancedTCA[®] Power male connector

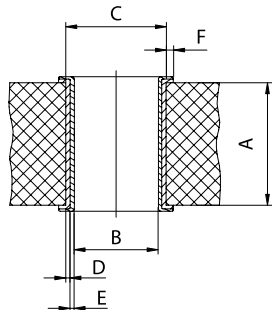

		Nominal hole	Ø 1.0 mm	Ø 1.6 mm
Imm. Sn printed circuit boards				
A	PCB thickness		min. 1.4 mm	min. 1.4 mm
B	Plated hole		Ø 1 + 0.09/-0.06 mm	Ø 1.6 + 0.09/-0.06 mm
C	Drill hole		Ø 1.15 ± 0.025 mm	Ø 1.75 ± 0.025 mm
D	Cu plating		min. 25 µm	min. 25 µm
E	Imm. Sn plating		max. 1.5 µm	max. 1.5 µm
F	Annular ring		min. 0.15 mm	min. 0.15 mm
Ni, Au printed circuit boards				
A	PCB thickness		min. 1.4 mm	min. 1.4 mm
B	Plated hole		Ø 1 + 0.09/-0.06 mm	Ø 1.6 + 0.09/-0.06 mm
C	Drill hole		Ø 1.15 ± 0.025 mm	Ø 1.75 ± 0.025 mm
D	Cu plating		min. 25 µm	min. 25 µm
E	Ni, Au plating		0.05 – 0.2 µm Au over 2.5 – 5 µm Ni	0.05 – 0.2 µm Au over 2.5 – 5 µm Ni
F	Annular ring		min. 0.15 mm	min. 0.15 mm

AdvancedTCA[®] Power female connector

		Nominal hole	Ø 1.0 mm	Ø 1.6 mm		
		Imm. Sn printed circuit boards				
		A	PCB thickness	min. 2.9 mm	min. 2.9 mm	
		B	Plated hole	Ø 1 + 0.09/- 0.06 mm	Ø 1.6 + 0.09/- 0.06 mm	
		C	Drill hole	Ø 1.15 ± 0.025 mm	Ø 1.75 ± 0.025 mm	
		D	Cu plating	min. 25 µm	min. 25 µm	
		E	Imm. Sn plating	max. 1.5 µm	max. 1.5 µm	
		F	Annular ring	min. 0.15 mm	min. 0.15 mm	
		Ni, Au printed circuit boards				
		A	PCB thickness	min. 2.9 mm	min. 2.9 mm	
		B	Plated hole	Ø 1 + 0.09/- 0.06 mm	Ø 1.6 + 0.09/- 0.06 mm	
		C	Drill hole	Ø 1.15 ± 0.025 mm	Ø 1.75 ± 0.025 mm	
		D	Cu plating	min. 25 µm	min. 25 µm	
		E	Ni, Au plating	0.05 – 0.2 µm Au over 2.5 – 5 µm Ni	0.05 – 0.2 µm Au over 2.5 – 5 µm Ni	
F	Annular ring	min. 0.15 mm	min. 0.15 mm			

MicroTCA[™] Power (backplane and power module output)

		Nominal hole	Ø 0.60 mm		
		Imm. Sn printed circuit boards			
		A	PCB thickness	min. 1.4 mm	
		B	Plated hole	Ø 0.60 ± 0.05 mm	
		C	Drill hole	Ø 0.70 ± 0.02 mm	
		D	Cu plating	min. 25 µm	
		E	Imm. Sn plating	max. 1.5 µm	
		F	Annular ring	min. 0.15 mm	
		Ni, Au printed circuit boards			
		A	PCB thickness	min. 1.4 mm	
		B	Plated hole	Ø 0.60 ± 0.05 mm	
		C	Drill hole	Ø 0.70 ± 0.02 mm	
		D	Cu plating	min. 25 µm	
		E	Ni, Au plating	0.05 – 0.5 µm Au over 2.5 – 5 µm Ni	
F	Annular ring	min. 0.15 mm			

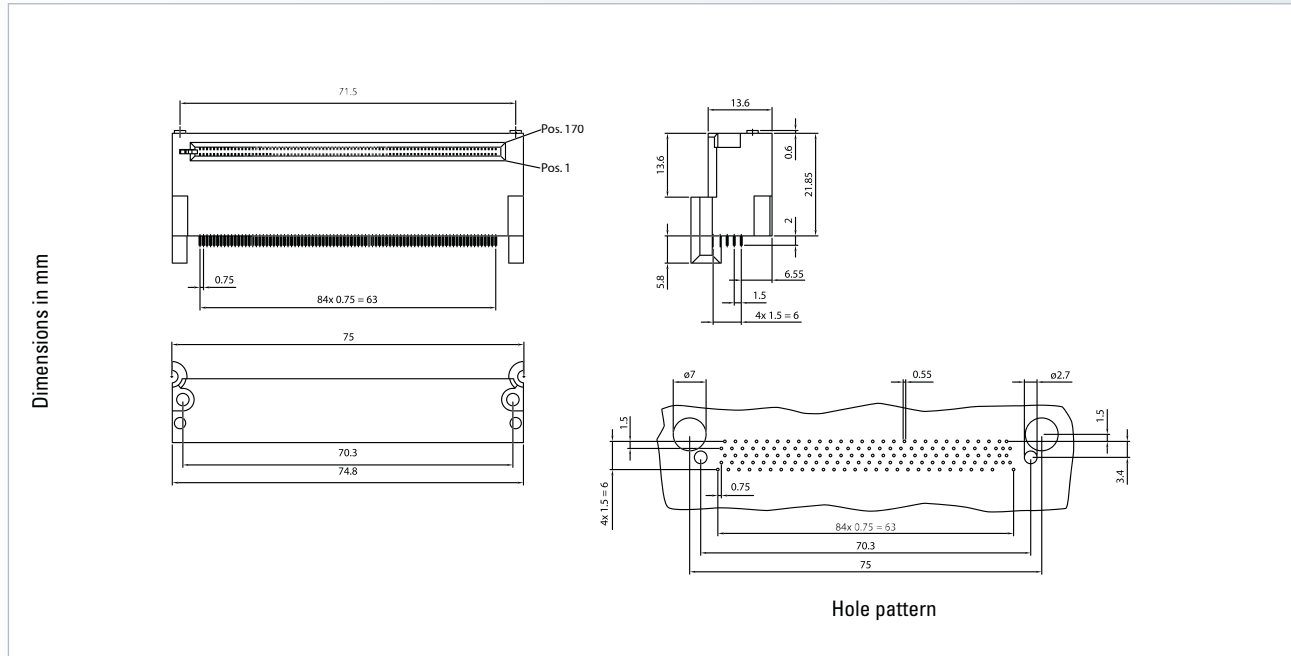

No. of contacts	Press-fit technology	
	Without peg	With peg
	Part number	
170	512-22170-453	512-23170-453

Accessories – Press-fit tool (see page 194) – Support tool (see page 195)
Cross reference – Function GuideSpring/ con:card+ [®] (see page 13)



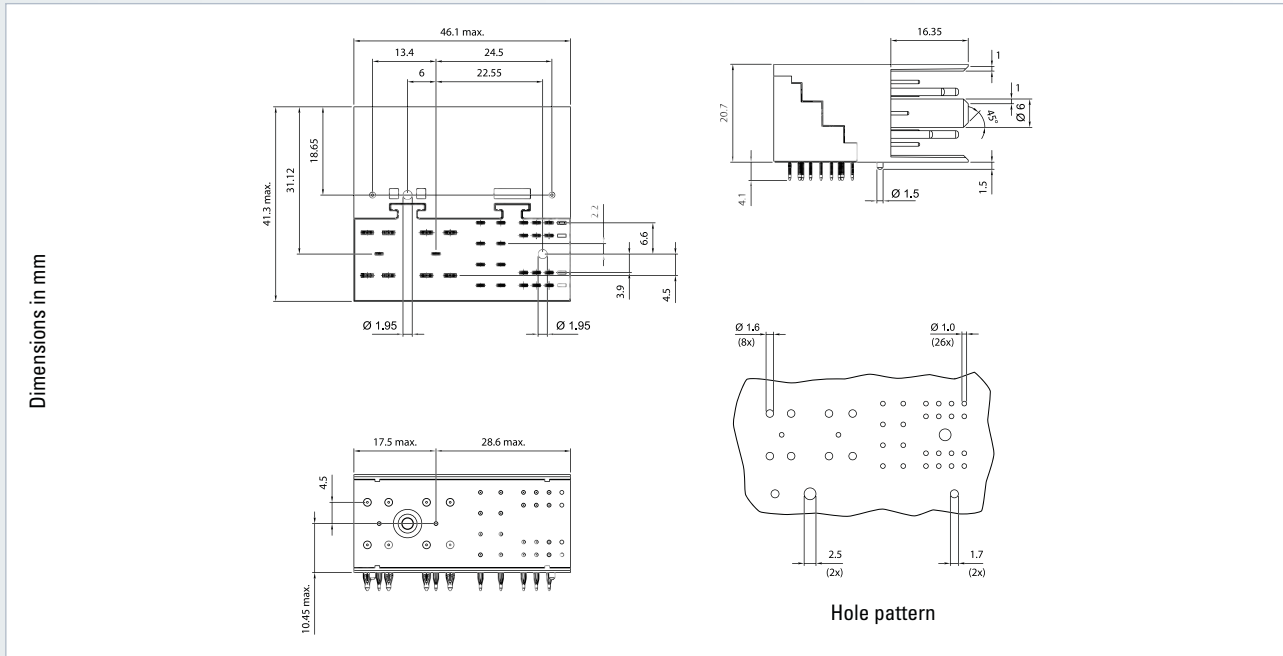

No. of contacts	Press-fit technology
	Part number
22 Signal 8 Power	511-50500-163
26 Signal 8 Power	511-50501-163

On request – Other contact numbers	Accessories – Press-fit tool (see page 194) – Support tool (see page 195)
--	--



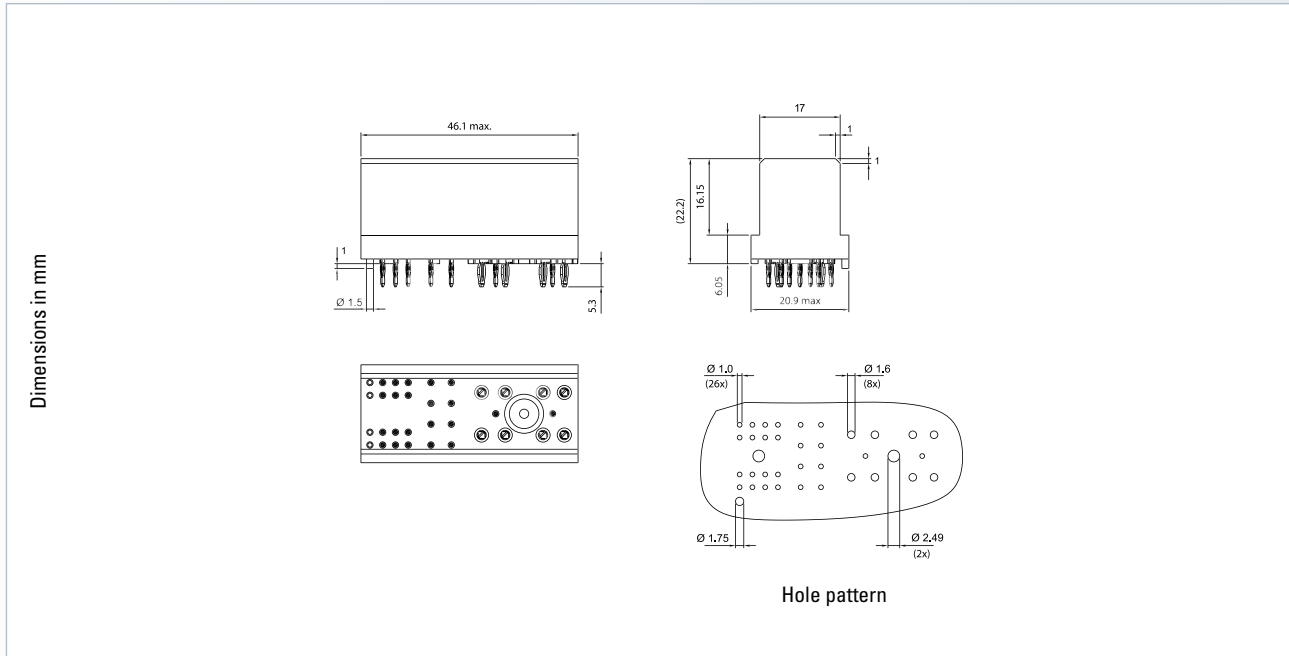

No. of contacts	Press-fit technology
	Part number
22 Signal 8 Power	512-50500-163
26 Signal 8 Power	512-50501-163

On request – Other contact numbers	Accessories – Press-fit tool (see page 194) – Support tool (see page 195)
--	--

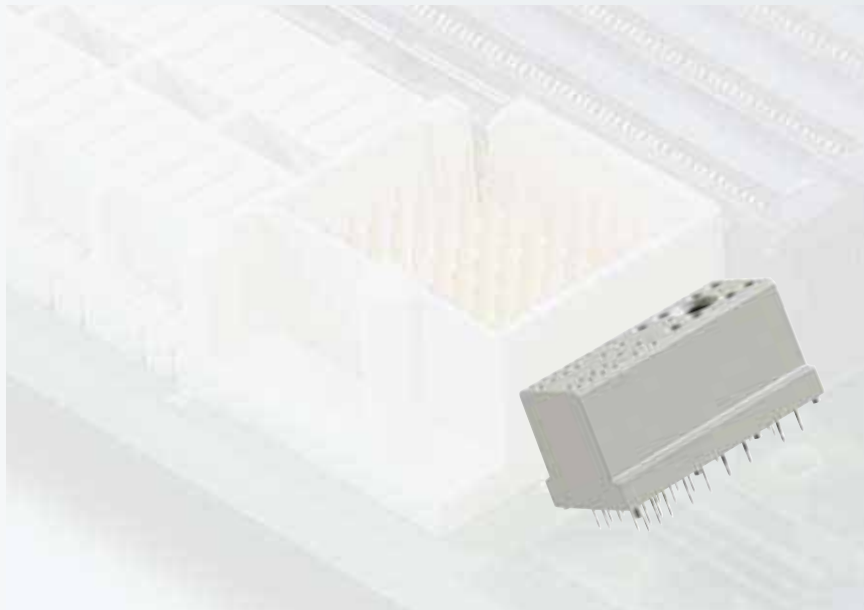



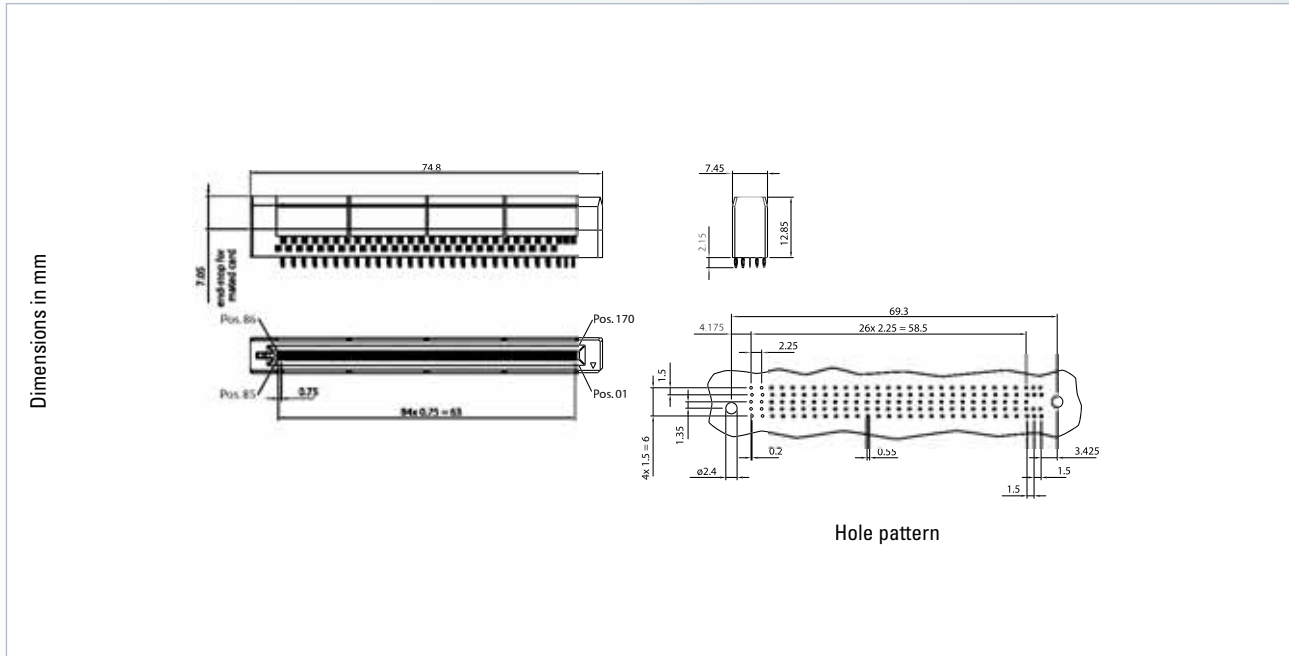

No. of contacts	Press-fit technology
	Part number
170	502-12170-153

On request – With peg	Accessories – Press-fit tool (see page 196) – Support tool (see page 197)
Cross reference – Function GuideSpring/ con:card+ ® (see page 13)	



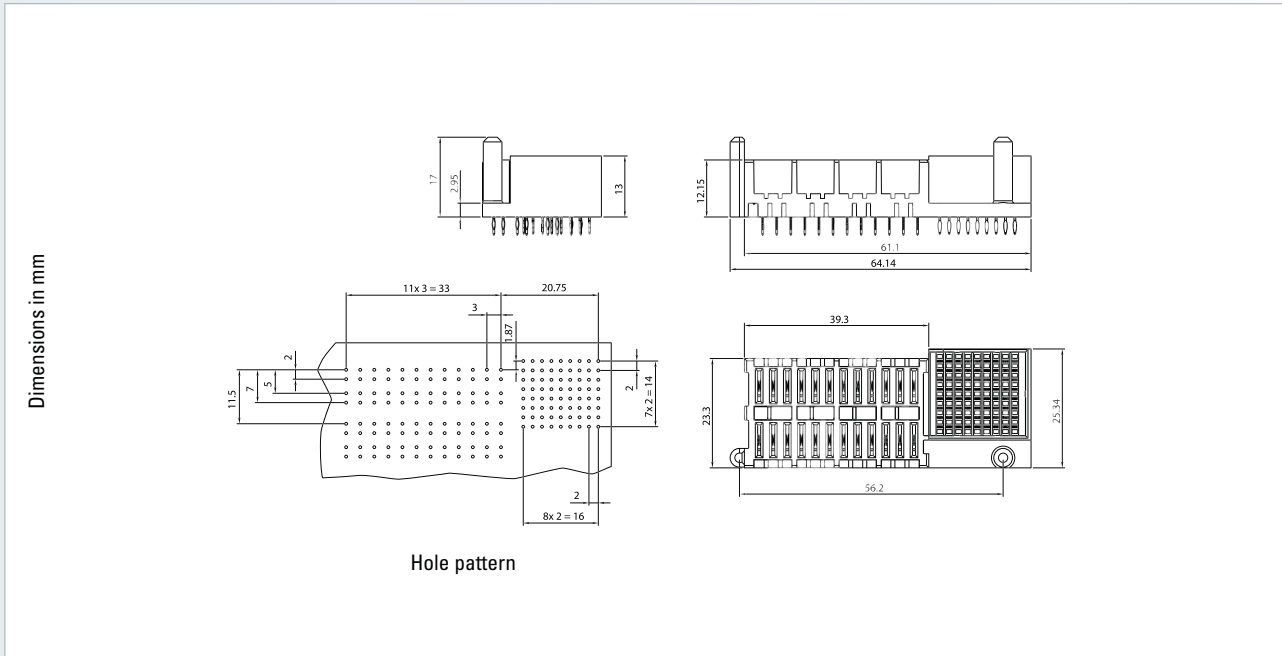

No. of contacts	Press-fit technology
	Part number
72 Signal 24 Power	502-50096-183

- Accessories**
- Press-fit tool (see page 196)
 - Support tool (see page 197)

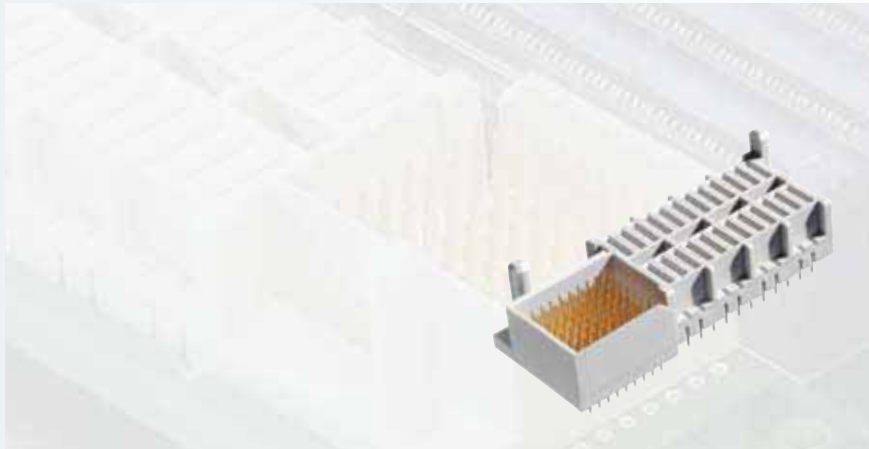

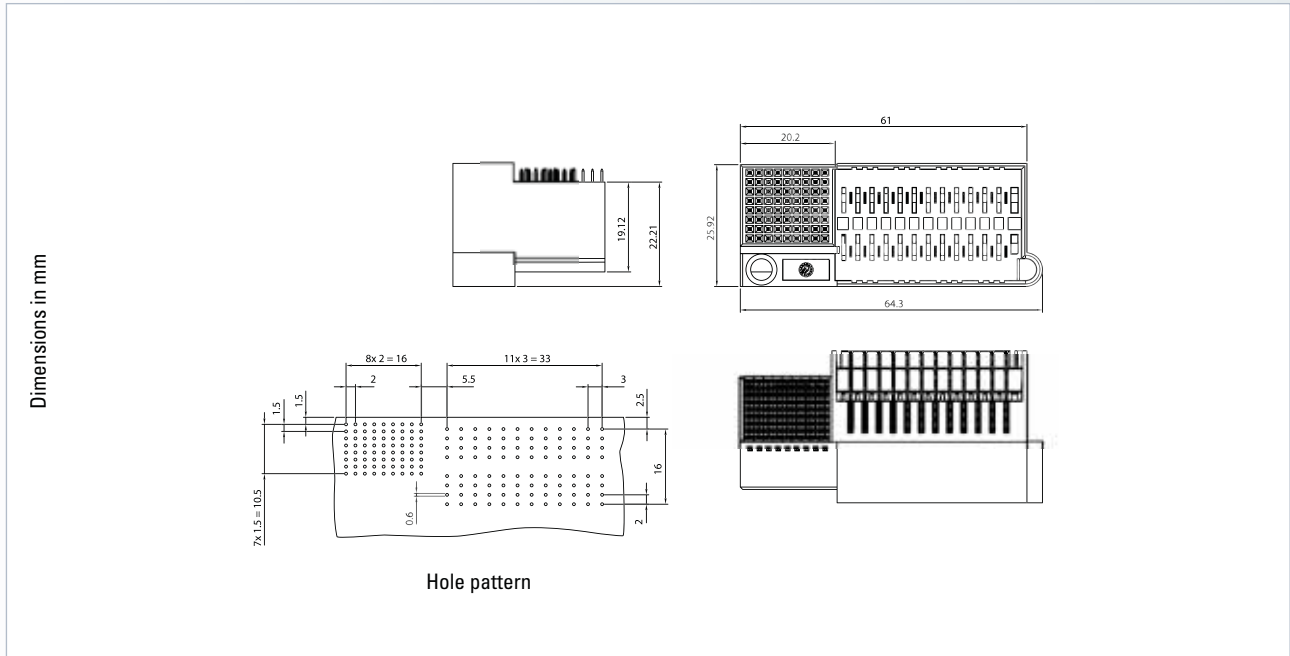

No. of contacts	Press-fit technology
	Part number
72 Signal 24 Power	501-50096-183

- Accessories**
- Press-fit tool (see page 196)
 - Support tool (see page 197)

